

TDC-3200W

DSP amplifier

TDC-3200W is a 2-channel high-end home cinema amplifier with intuitive controls and simple installation. It offers two channels of 1600W into 4 Ohm and is equipped with balanced and unbalanced inputs and balanced outputs for quick linking. The amplifier is easily accessed with user-friendly Web UI, giving total control over room EQ, channel delay, channel volume, status monitoring as well as other functions.

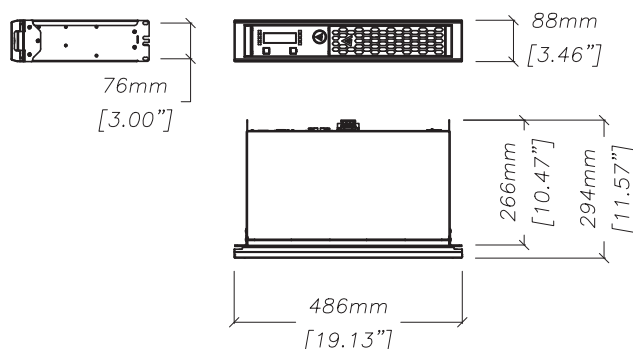

SAFETY INSTRUCTIONS

1. Do not use this equipment near water.
2. Clean only with dry cloth.
3. Do not block any ventilation openings. Install in accordance with the manufacturer's instructions.
4. Do not use near heat sources such as stoves, heat registers, radiators or other equipment (including amplifiers) that produces heat.
5. Do not use the unit near open fire sources.
6. Connect the unit only to the electric network with grounding. Use only electric plugs that provide grounding.
7. Protect the power cord from being walked on, pinched, or otherwise damaged.
8. Use only accessories specified by the manufacturer.
9. Unplug this unit during lightning storms or when unused for long periods of time.
10. Refer all servicing to qualified service personnel. Servicing is required when the system has been damaged in any way, such as power supply cord or plug is damaged, liquid has been spilled or objects have fallen into the unit, the unit has been exposed to rain or moisture, does not operate normally, or has been dropped.
11. **WARNING - TO REDUCE THE RISK OF FIRE OR ELECTRIC SHOCK, DO NOT EXPOSE THIS SYSTEM UNIT TO RAIN OR MOISTURE.**

SPECIFICATIONS

Frequency range	20 Hz - 20 kHz
Channel count	2
Nominal power, per ch., 4 Ohm	1600W
Nominal power, per ch., 8 Ohm	1100 W
Nominal power, two ch. bridged, 8 Ohm	3200 W
Nominal power, two ch. bridged, 16 Ohm	1600 W
Amplifier	Class D high efficiency
DSP audio controls	6-band parametric EQ Volume Polarity Delay
DSP utility controls	Power saving mode Power-up mode
Maximum input level	+20dBu
Input impedance	18 kOhm unbal., 36 kOhm bal.
Crosstalk separation	85 dB @ 1 kHz
THD	<0,5% from 0,1 W to full power (typical <0,01%)
Power consumption, 1/8 of max output power @ 8 Ohm	600 VA
Damping factor @ 8 Ohm	> 500 @ 100 Hz
S/N ratio	100 dB
Connectors	2x RCA unbal. input 2x XLR female bal. input 2x XLR male bal. output 4-pin Phoenix speaker terminal RJ-45 Ethernet
Dimensions	486 x 88 x 294 mm, 2U
Net weight	5,9 kg